

Particulate Measurement System

PROCESS & EMISSIONS MONITORING SYSTEMS



PROSCATTER™
INSIDE

SPECIFIC FEATURES:

- *ProScatter*® Forward-scatter technology with a minimum detection limit of $<0.05\text{mg/m}^3$
- Complies with Waste Incineration Directive and Large Combustion Plant Directive EN 13284-2 and EN 14181 (Europe)
- *ProScatter*® technology provides enhanced measurement due to reduced cross-sensitivity to particle type and size compared to other scatter monitors
- Forward-scatter measurement technique with automatic zero and span checks that fully challenge the system's ability to measure forward-scattered light and satisfy daily drift checks
- Robust and rugged for challenging high-temperature $500\text{ }^\circ\text{C}$ stack conditions and Ex hazardous zones

COMPLIANCE WITH:

EN 14181 and EN 13284-2



Suitability Tested
EN 15267
QAL1 Certified
Regular
Surveillance

www.tuv.com
ID 0000038496



TECHNOLOGY / APPLICATION

SYSTEM OVERVIEW

The PCME QAL 181 sensor is suitable for measuring particle emissions from most dust arrestment plant.

The PCME QAL 181 utilises ENVEA's patented *ProScatter*[®] forward-scatter measurement technique for measuring particulate concentration levels, typically between 0.05 mg/m³ and 300 mg/m³.

As an approved particulate CEM complying with monitoring standards EN14181, EN13284-2, the instrument holds QAL1 approvals the requirements of EN 15267-3 with both MCERTS version 3 Class 1 and TUV BlmSchV 17, 13, 27 latest revision approvals. As such, the instrument provides a precise and robust solution for monitoring according to EN14181 with special relevance to the European Waste Incineration Directive (WID) and Large Combustion Plant Directives (LCPD).

Due to the rugged design the PCME QAL 181 *ProScatter*[®] particulate monitoring system is suitable for use in a wide range of applications within the Power Incineration, Cement, Chemical, Metal, Mineral and Petrochemical industries.



© Lühr Filter. Incinerator. Image reproduced with kind permission.

PRINCIPLE OF OPERATION

The PCME QAL 181 utilises an improved forward-scatter technique *ProScatter*[®] featuring patented options for enhanced reliability.

As particles travel through a beam of light, each particle scatters light in all directions with the strongest intensity of light being scattered in a forward direction (Figure 1).

The patented *ProScatter*[®] forward-scatter sensor uses a beam of light transmitted by a laser along the probe and through the measurement area. The beam of laser light then continues through a concave mirror to the beam dump (Figure 2).

The forward-scattered light collected by the concave mirror is then focused onto a quartz rod where the light is transmitted towards the light detector positioned within the electronic enclosure located outside the stack. The amount of light detected is proportional to the particulate concentration.

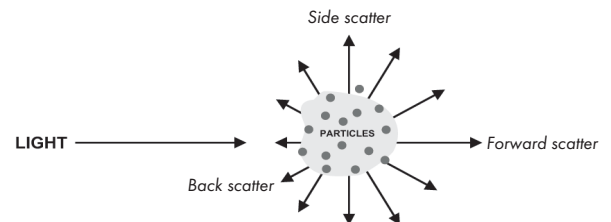

Figure 1: Principle of Scattered Light

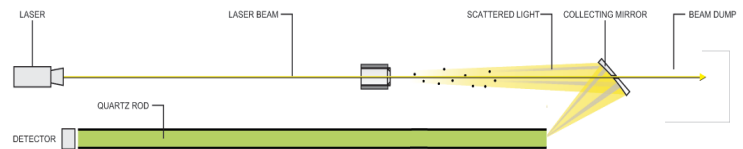

Figure 2: ENVEA's *ProScatter*[™] Sensor



Class 3R Laser Product – AVOID DIRECT EYE EXPOSURE!

INBUILT QUALITY ASSURANCE

Measurement Mode

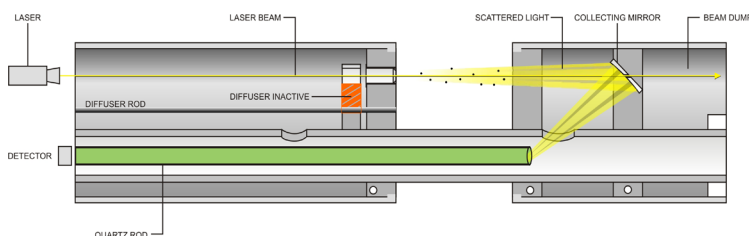

Span check with diffuser performs QAL3

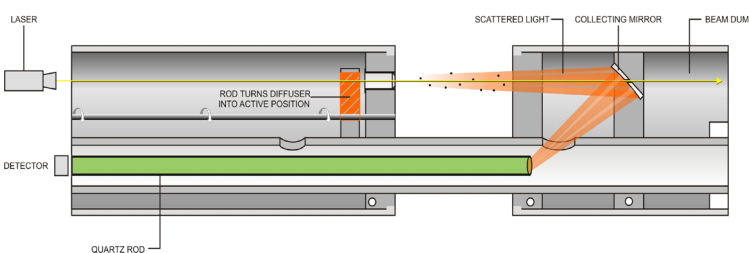

Figure 3: Sensor Self-checks

The PCME QAL 181 *ProScatter*[®] technique benefits from improved levels of performance when compared to other forward-scatter systems due to its increased area of detection (more than 10x larger) and smaller angles of incidence, thus reducing variability in sensitivity and measurement due to particle type and size as found in other scatter monitors.

The PCME QAL 181 sensor has automatic zero and span self-checks that fully challenge the forward-scatter measurement technique. In addition, internal diagnostic checks running in the background ensure a high level of confidence in the quality of the measurement and permit early diagnosis of any deterioration in system performance.

The sensor self-checks ensure appropriate quality assurance to meet the QAL3 regulatory requirements for particulate compliance monitors installed on Incinerators, Cement Kilns and Power Plant in Europe (EN13284-2).

The automatic sensor self-check employs a reference scattering body, which is periodically positioned into the measurement path, providing a full check of the instrument's capability to measure forward-scattered light, unlike other systems which use ratios of laser intensity as reference check or do not challenge the optical path of the measurement mode.

PRODUCT FEATURES

QUALITY ASSURANCE/AUDITING

The PCME QAL 181 *ProScatter*® forward-scatter instrument is supported by Filter Audit units that use ‘scattering bodies’, an approved reference material for conducting quarterly Linearity checks as part of AST or QAL2 procedures.

To audit the instrument, the sensor is temporarily removed from the stack and the Filter Audit units are inserted into the PCME QAL 181 measurement zone (Figure 4). The resulting response is measured to ensure linearity and also to provide a reference check that ensures contamination is not affecting instrument performance.



Figure 4: Audit filters for instrument linearity and reference checks

USER INTERFACE

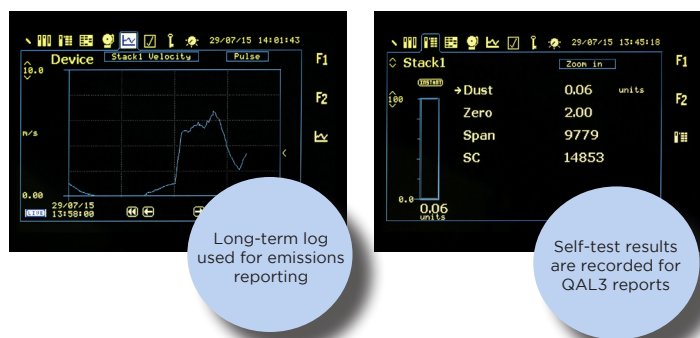

The PCME QAL 181 *ProScatter*® forward-scatter system is comprised of the sensor probe, which is mounted directly in the stack, and a control unit that provides power and digital communication for the sensor.

The Standard control unit provides configuration, graphical displays and recording of emissions for a single sensor system. The PRO version of the system (with a ProController) extends this to 32 sensor channels and includes Ethernet capability along with additional data storage for emission reporting and data redundancy.

Onboard normalization can be accomplished by using additional 4–20mA inputs from external devices, such as oxygen and temperature transmitters. Flow sensors for calculating Mass emissions can be accommodated along with additional I/Os to the controllers.

The system supports industry standard Modbus communication and can be connected directly to a PLC or CEMS management system. The QAL Reporter PC software (Figure 5) can be used with the instrument to provide secure and powerful emissions reporting and automated QAL3 reporting in full compliance with EN13284-2 and EN14181.

The control unit also provides four data loggers (controller specific): Pulse data logger for instantaneous data, which holds the last two hours of data from a single-sensor system. Short-term data for storing a rolling 24 hrs of 1-minute averaged data from a single sensor for process control. Long-term data for storing up to one year of rolling 15-minute averaged data from a single sensor for emission monitoring.

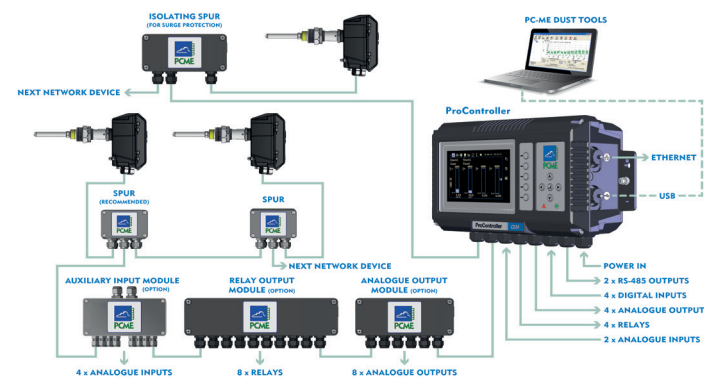

Alarm data logger for a rolling 500 alarm events from a single sensor.

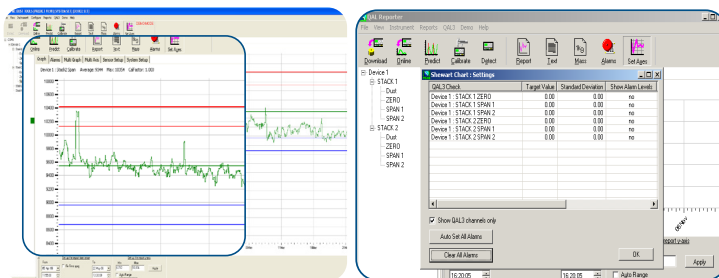

Figure 5: QAL Reporter module with QAL3 control charts of automatic zero and span data

ADDED VALUE FEATURES AND BENEFITS

The PCME QAL 181 *ProScatter*® forward-scatter system’s rugged design provides durable long-term measurement. In addition to the reduced cross-sensitivity to changing particulate type and size, increased instrument lifetime and improved measurement reliability are indicated due to:

- No moving parts in the instrument path for increased lifetime and reliable measurement.
- Suitable for stacks with flue gas temperatures up to 500°C, using a high-quality Quartz rod for transmission of forward-scattered light to the detector. The Quartz rod will not age prematurely and become brittle when used at elevated temperatures, in contrast to other forward-scatter systems that use fibre-optic cables.

- Inbuilt data logging, recording of measured particulate and internal diagnostic value for added confidence and security of data.
- TCP/IP Ethernet, RS485, RS232, 4x4 - 20mA outputs, 1x 4-20mA input, 4x Relay outputs, 1x Relay input for increased choice of integration with your DCS or DAHS (controller specific).
- Powerful multilingual, text-driven menu for setup without the use of external equipment, with a large display for an improved user experience.
- Proven rugged, robust mechanical design for harsh environments.

SPECIFICATIONS

Network Controllers		Standard Controller	ProController
Overview	Number of sensors/channels	1	1-32
	Display	Two-tone grey, backlit graphical LCD	High-contrast, anti-glare 7" (viewable) TFT LCD
	Multiple Data Viewing	PC or RS-485	PC/RS-485/Ethernet simultaneously
	Dimensions	W220 x H123 x D80 mm	W390 x H221 x D118 mm
	Power supply voltage	100-240V AC (50/60 Hz)	85-265V AC (50/60 Hz)
	Protection Rating	IP65	IP66
	Ambient Temperature Range	-20°C to 50°C	-20°C to 50°C
Features and Functions	Navigation keys	UP/DOWN/LEFT/RIGHT/ENTER	UP/DOWN/LEFT/RIGHT/ENTER plus 5 function keys: 3x short-cut keys and 2 user-programmable keys
	Icon-driven, multilingual menus	n/a	✓
	Secure password protection	✓	✓
	Sensor system setup and configuration options	✓	✓
	Configurable emission alarm levels	✓	✓
	Sensor calibration screens	✓	✓
	Seamless integration with existing control units and sensors	n/a	✓
Data Logging*	Long-term Log	12 months @ 15 minutes	48 months @ 15 minutes
	Short-term Log	7 days @1 minute	28 days @ 1 minute
	Pulse Log	8 hours @ 1 seconds	32 hours @ 1 second
	Alarm Log	500 entries	500 entries
System Outputs	Ethernet (RJ45)	n/a	✓ Connection type: 100Base-T/Tx 100 Mb/s
	USB 2.0	n/a	✓ Suitable for connecting to a local PC or laptop
	Relays	2 off (programmable)	4 off (programmable)
	4-20mA	1 off (programmable)	4 off (programmable)
	RS-485	1	1
System Inputs	Digital User selectable for: PLANT OFF indication, Bag-filter cleaning sequences, multiple calibrations	1	4
	4-20mA	0	2

*Data logging capacity for one sensor. Data stored varies per sensor type. Please consult ENVEA for specific data.

Network Accessories		Standard Controller	ProController
Network Modules (can be connected to Controller Network systems to provide additional Inputs and Outputs)	Analogue Output Module (AOM) provides 8 additional 4-20 mA outputs definable to sensors/channels	1	1-8
	Auxiliary Input Module (AIM) provides 4 additional digital inputs, plus 4 additional relay outputs	1	1-8
	Relay Output Module (ROM) provides 8 additional relay outputs	1	1-8
	SPUR provides sensor network connection and local isolation during maintenance	1	1-32
	Power Supply Repeater (PSR) provides voltage and signal boost for extended cable runs and large sensor networks	1	1-8

	181 SENSOR
Enclosure Material	Die-cast aluminium (polyester powder coated)
Connection Required on Duct	Hole pattern to suit DN80 PN10/PN16 or 3" 150lb ANSI (hole ID at least \varnothing 88mm)
Power Requirements	24V provided by the control unit
Cable Entries	3x M20 cable entry glands
Air Purge Requirements	Requires continuous air purge at 30-40 litres/minute

	IECEX	ATEX
GAS ZONE	ZONE 2	
Certificate number:	IECEX SIR 10.0125X	Sira 10ATEX4260X
Certificate code:	Ex ec op is IIC T4 Gc Ta = -20°C to +55°C	Ex ec op is IIC T4 Gc Ta = -20°C to +55°C II 3G
DUST ZONE	ZONE 21/22	
Certificate number:	IECEX SIR 10.0125X	Sira 10ATEX9375X
Certificate code:	Ex tb IIIC T63°C Db IP66 Ta = -20°C to +55°C	Ex tb IIIC T63°C Db IP66 Ta = -20°C to +55°C II 2D

	Nominal	Adjustable Insertion	Overall Length
Insertion Length	550 mm	80-560 mm	680 mm

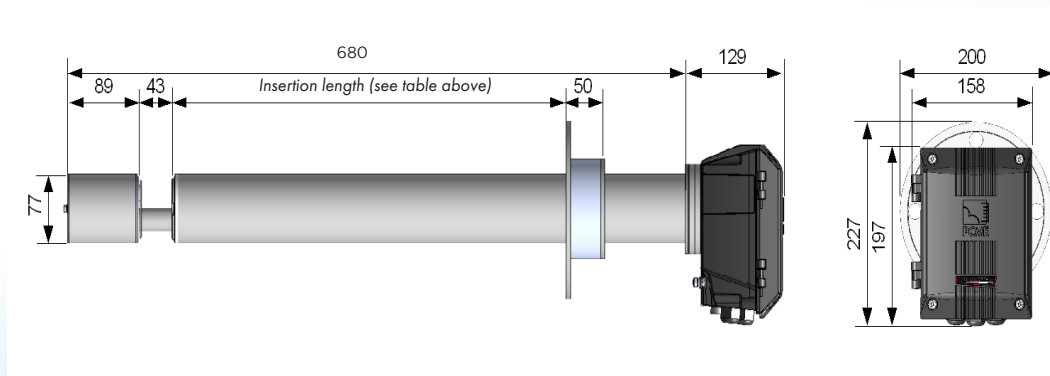

ABOUT ENVEA

As a progressive environmental Company, ENVEA specialises in particulate measurement for industrial processes. With a worldwide reputation for reliability, innovation and technological excellence, the Company produces under the trademark envea™ equipment for concentration and mass monitoring for regulatory, environmental and process control requirements. A dedicated team of qualified application and sales engineers is always on hand and should be consulted in the selection and usage of the most suitable equipment for any particulate application.



ENVEA UK
 ENVEA House Rose and Crown Road
 Swavesey / Cambridge - UK CB24 4RB
 ☎ +44 (0)1480 468200
 ✉ contact.gb@envea.global

